

Effective
from 1 January
2023

Business services and postal prices

For business account customers



t: 616617
e: business@jerseypost.com
www.jerseypost.com/pricing

**Jersey
Post** 

Introduction

This guide contains the current business account prices for customers who use an account (either a postage account or outsourced mailroom), a franking meter or our online postage portal to pay for their postal services.

Account customers	Online postage customers
Stamp rate 1% discount	Stamp rate 2% discount

Franking Meter customers will be charged the standard postage rate.

For ease of reference, the prices shown within this document include the applicable discounts outlined in the table above.

For further information or clarification on postage prices, please visit www.jerseypost.com/pricing. Alternatively, please contact our business sales team on **616617** or email business@jerseypost.com for enquiries regarding other aspects of our postal services.

Contents

Top tips for sending	3	Business Accounts	12
Customs requirements for sending off Island	4	Postage Account	12
How does this impact business accounts?	5	Outsourced Mailroom	13
Discounted Business Postage	6	Franking Meter	13
Pricing structure	6	Prepaid Import VAT Accounting Scheme	14
Choose your destination	7	Other related services	14
Choose your mail format	8	Business Redirection Service	14
Premium Postage	9	Retention of Mail Service	14
Track the delivery	9	Business Delivery Services	15
Enhance compensation	9	Local Same Day Courier	16
Courier	11	Mail Scanning Services	16
Online Postage Portal	12	Responses Services	17
		Direct2home	18
		Van Advertising	19
		Fetch.je	19

Top tips for sending

Addressing Standards

Following the tips below will help to ensure that your posted items avoid any unnecessary delays as they pass through the postal network.

Correctly labelling an address:



Local Address

Name of Addressee
House name
Street name
PARISH (in capitals)
POST CODE (in capitals)



PO Box Address

Name of Addressee
PO Box Number
PARISH (in capitals)
POST CODE (in capitals)



Premium Postcodes

Name of Addressee
PARISH (in capitals)
PREMIUM POSTCODE
(in capitals)



UK Address

Name of Addressee
House number and street name
CITY or TOWN (in capitals)
POST CODE (in capitals)

Speedy Processing:



Channel Islands

Please do not include Channel Islands at the end of the address.



Avoid full stops

Letter sorting machines process more quickly if there are no full stops or commas at the end of address lines.



Always include the post code

Always include the POST CODE on its own in capitals on the last line of the address.



Include a return address

It's always best to include a return address on items that you're sending, especially those being sent off island. In that way, any items that can't be delivered can be returned directly to you.

Dangerous and Restricted Items:

There are certain things that for health, safety and environmental reasons you are not permitted to send through the postal network.

- **Prohibited Goods**

Must never be sent or received using our Postal Service.

- **Restricted Goods**

Can be sent or received using our Postal Service providing you follow the rules for appropriately packaging and labelling the items. To download our full guide to Prohibited and Restricted Goods, please visit:

www.jerseypost.com/restricteditems

Stationery and Packaging:

If you require postal stationery including postage bags, please place your order by emailing: csr@jerseypost.com

Customs requirements for sending off Island

Electronic customs data is now required when sending goods/merchandise off Island.

Electronic Advance Data (EAD)

If you're sending goods/merchandise overseas, whether to the UK or internationally, your parcel requires an electronic customs declaration to be completed.

Due to significant changes in the international trading landscape, paper based CN22 and CN23 are no longer valid, and this information is now required electronically and in advance of items arriving at their destination.

What information is needed?

In addition to the information that was required when completing paper based CN22 and CN23 forms, senders must now also state the **quantity, weight and value of each item** within the parcel.

Paper based customs labels are no longer valid when sending items to the UK or internationally. Customs information must now be sent electronically and in advance of items arriving at their destination.



How does this impact business accounts?

Postage Account Customers

Letter and Large Letter items can continue to be processed using the green docket books, as these items do not require customs declarations. Items being sent off Island containing goods/merchandise sent in Parcel and Large Parcel formats can no longer be processed in the green book. Postage Account customers should process and purchase their parcel items online to ensure all items posted meet the electronic pre-advice requirements and are not held up on arrival at their destination. Your electronic label will be completed online and available for download and print. The online postage portal charges will be applied to your business account and invoiced monthly.

Outsourced Mailroom Customers

Letter and Large Letter items can continue to be processed using the outsourced corporate mailroom as these items do not require customs declarations. Items being sent off Island containing goods and/or merchandise sent in Parcel and Large Parcel formats can no longer be processed via the outsourced corporate mailroom. To ensure all items posted meet electronic pre-advice requirements and are not held up on arrival at their destination, we are encouraging customers to process and purchase their parcel items online. Your electronic label will be completed online and available for download and print. The online postage portal charges will be applied to your business account and invoiced monthly.

Franking Meter Customers

Letter and Large Letter items can continue to be processed using your franking machine as these items do not require electronic pre-advice customs labels. Items being sent off Island containing goods and/or merchandise sent in Parcel and Large Parcel formats can no longer be processed using a franking machine. To ensure all items posted meet electronic pre-advice requirements and are not held up on arrival at their destination, we are encouraging customers to process and purchase their parcel items online. Your electronic label will be completed online and available for download and print.

eCommerce Customers

Due to the volumes of items sent by our eCommerce customers, we recommend integrating directly with our shipping platform Atlas. For more details, please contact your account manager to discuss your requirements and agree on the best method for integration.

The Universal Postal Union has made this a global requirement for postal authorities. Providing Electronic Advance Data (EAD) improves security, reduces delays and provides customers with a better international service. Items without EAD can be held in the destination country, delayed, returned or even destroyed.

Pricing structure

Shown below is the way in which we calculate our postage.

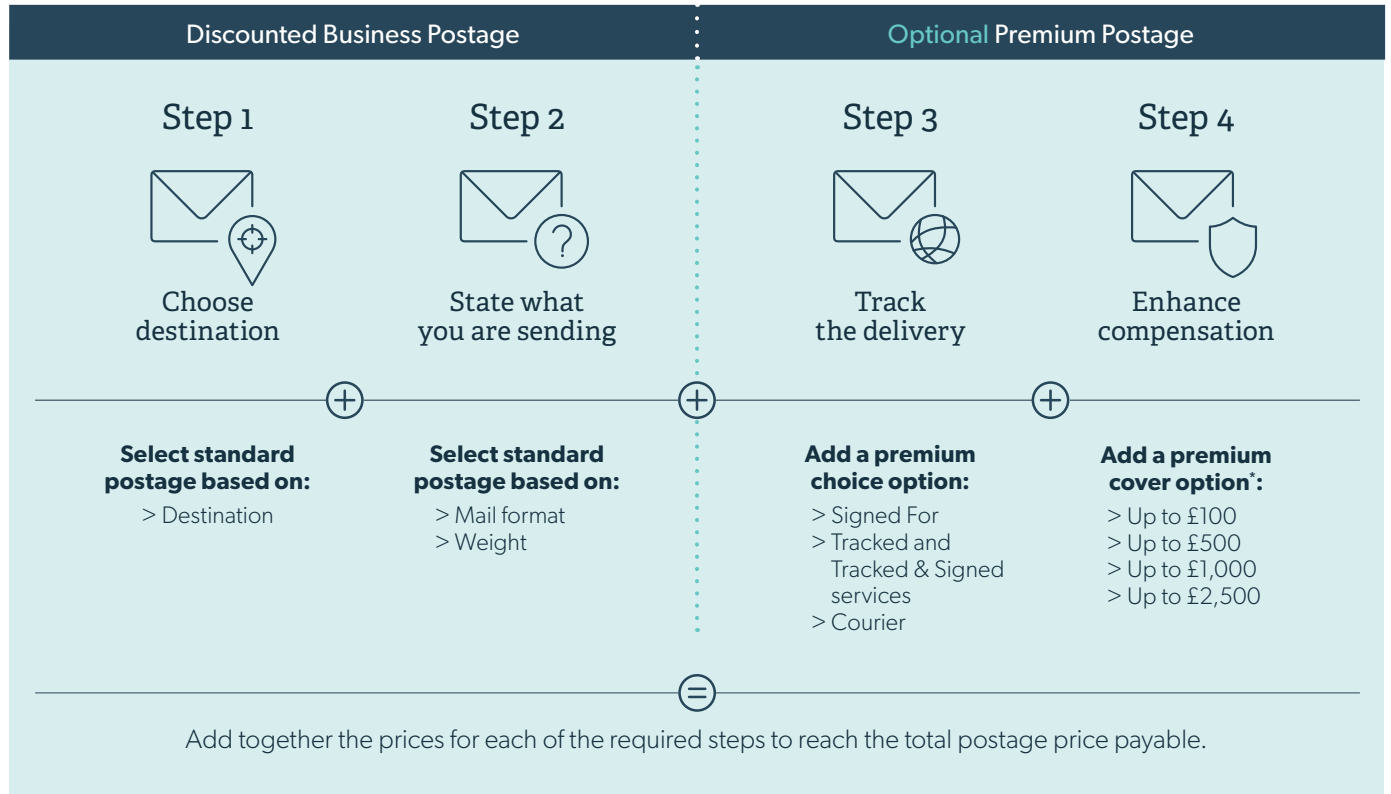

* Level of cover available dependent on destination.

IMPORTANT: Any format can be used for Goods and/or Merchandise being sent to the UK. International items containing Goods and/or Merchandise must be sent using Parcel or Large Parcel formats.

1. Choose your destination



Discounted Business Account Prices

Postage Account and Outsourced Mailroom customers are entitled to a 1% postage price discount. Customers using online services are entitled to a 2% postage price discount and Franking Meter customers will be charged at the standard postage rate.

Calculate the price for your item by selecting the correct format, weight step and destination from the table below.

	Weight	Local			UK, IOM & other CI			Europe			Rest of World		
		Standard/ Franked	Account	Online	Standard/ Franked	Account	Online	Standard/ Franked	Account	Online	Standard/ Franked	Account	Online
Letter	100g	£0.60	£0.59	£0.59	£0.98	£0.97	£0.96	£1.85	£1.83	£1.81	£2.55	£2.52	£2.50
Large Letter	100g	£0.98	£0.97	£0.96	£1.65	£1.63	£1.62	£3.25	£3.22	£3.19	£4.20	£4.16	£4.12
	250g	£1.45	£1.44	£1.42	£2.50	£2.48	£2.45	£5.04	£4.99	£4.94	£8.26	£8.18	£8.09
	500g	£2.19	£2.17	£2.15	£3.55	£3.51	£3.48	£9.08	£8.99	£8.90	£14.52	£14.37	£14.23
	750g	£2.87	£2.84	£2.81	£4.40	£4.36	£4.31	N/A	N/A	N/A	N/A	N/A	N/A
Parcel	250g	£1.67	£1.65	£1.64	£3.90	£3.86	£3.82	£5.80	£5.74	£5.68	£8.49	£8.41	£8.32
	500g	£2.16	£2.14	£2.12	£6.12	£6.06	£6.00	£11.40	£11.29	£11.17	£16.60	£16.43	£16.27
	1kg	£3.74	£3.70	£3.67	£8.52	£8.43	£8.35	£19.10	£18.91	£18.72	£30.60	£30.29	£29.99
	1.5kg	£5.32	£5.27	£5.21	£10.92	£10.81	£10.70	£26.60	£26.33	£26.07	£44.60	£44.15	£43.71
	2kg	£6.91	£6.84	£6.77	£13.02	£12.89	£12.76	£33.80	£33.46	£33.12	£58.70	£58.11	£57.53
Large Parcel	5kg	£10.20	£10.10	£10.00	£20.80	£20.59	£20.38	£79.40	£78.61	£77.81	£100.70	£99.69	£98.69
	10kg	£10.50	£10.40	£10.29	£22.00	£21.78	£21.56	£99.10	£98.11	£97.12	£141.00	£139.59	£138.18
	20kg	£10.90	£10.79	£10.68	£24.20	£23.96	£23.72	£132.70	£131.38	£130.05	£217.40	£215.23	£213.05
	30kg	£11.30	£11.19	£11.07	£26.40	£26.14	£25.87	£161.30	£159.69	£158.07	£289.90	£287.01	£284.10

Parcels being sent overseas, whether to the UK or internationally, require electronic pre-advice customs data and therefore can no longer be processed using a Postage Account or Franking Machine. To create these labels, please use our online postage portal at www.jerseypost.com/onlinepostage.

2. Choose your mail format

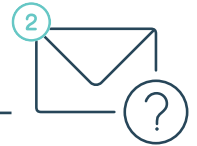

Shown below are our current Standard Postage mail format and weight specifications.

Letters, Cards and Documents		Parcels, Goods and Merchandise	
<p>Letter</p> <p>Up to 100g</p> <p>Thickness 5mm (max)</p>	<p>Large Letter</p> <p>Up to 750g*</p> <p>Thickness 20mm (max)</p> <p>*Max weight for International large letter items is only up to 500g</p>	<p>Parcel</p> <p>Up to 2kg</p> <p>Combined L + W + D Up to 900mm</p>	<p>Large Parcel</p> <p>Up to 30kg</p> <p>Combined L + W + D Up to 3000mm</p>

Large Parcels - Any item that exceeds either the measurements or the weight of a Parcel shown above is classified as a Large Parcel. Most destinations accept Large Parcels up to a maximum of 30kg, but there are some destinations that will only accept 20kg or less.

Mail formats for goods/merchandise items

Any mail format can be used for goods/merchandise being sent to the UK. However, for goods/merchandise being sent to international destinations parcel formats must only be used.

EXAMPLE

If you can fit a scarf into a 'Large Letter' and it is within the given dimensions, you will only be charged the 'Large Letter' price and not the 'Parcel' price.

Electronic Advance Data (EAD) is still required as it contains goods/merchandise.

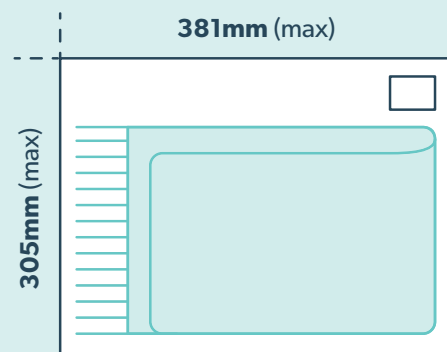

3. Track the delivery (Premium Postage)



Our range of Premium Postage options allows you to build the service that best suits your needs by adding tracking, compensation and/or an express delivery option.

Tracked and Tracked & Signed services

If you need to know where your item is at any point during its journey, select the level of tracking from the table below.

Tracked options	Local	UK, IOM & other CI	Europe	Rest of World
Signed For <i>(Requires a signature on delivery. Includes £30 cover).</i>	N/A	£2.95	£3.95	£4.95
Tracked and Tracked & Signed services <i>Tracked provides tracking as it moves through the postal network. Tracked and Signed provides the latter but also requires a signature on delivery. Includes £100 cover).</i>	£1.95	£6.95	£7.95	£8.95
Courier <i>(Provides secure and speedy handling and delivery through our global courier partner FedEx. Includes £500 cover).</i>	Please contact our business team for the latest rates.			

*Premium services vary according to country. For country specific details visit www.jerseypost.com

4. Enhance compensation (Premium Postage)



Premium Cover

If the item you are sending is valuable, you can enhance the level of cover provided by adding the appropriate level of compensation from the table below. Compensation is provided only in the event of loss or damage to an item. Use our Courier service for delay cover.

Compensation options	Local	UK, IOM & other CI	Europe	Rest of World
Up to £100	£3.50	£3.50	£3.50	£3.50
Up to £500	£8.50	£8.50	£8.50	N/A
Up to £1,000	£13.50	£13.50	N/A	N/A
Up to £2,500	£25.00	£25.00	N/A	N/A

Please note that for Signed For items, the maximum cover available is up to £500. This excludes Rest of World destinations where maximum cover available is up to £100 for Signed For and Tracked & Signed items. For higher levels of cover, please use our Courier service (more details on page 13).

EXAMPLE

The postage rate you pay will be calculated by the type of item being posted as well as the format, weight and destination of the item(s), plus the price of any additional Premium Postage options. See below for example:

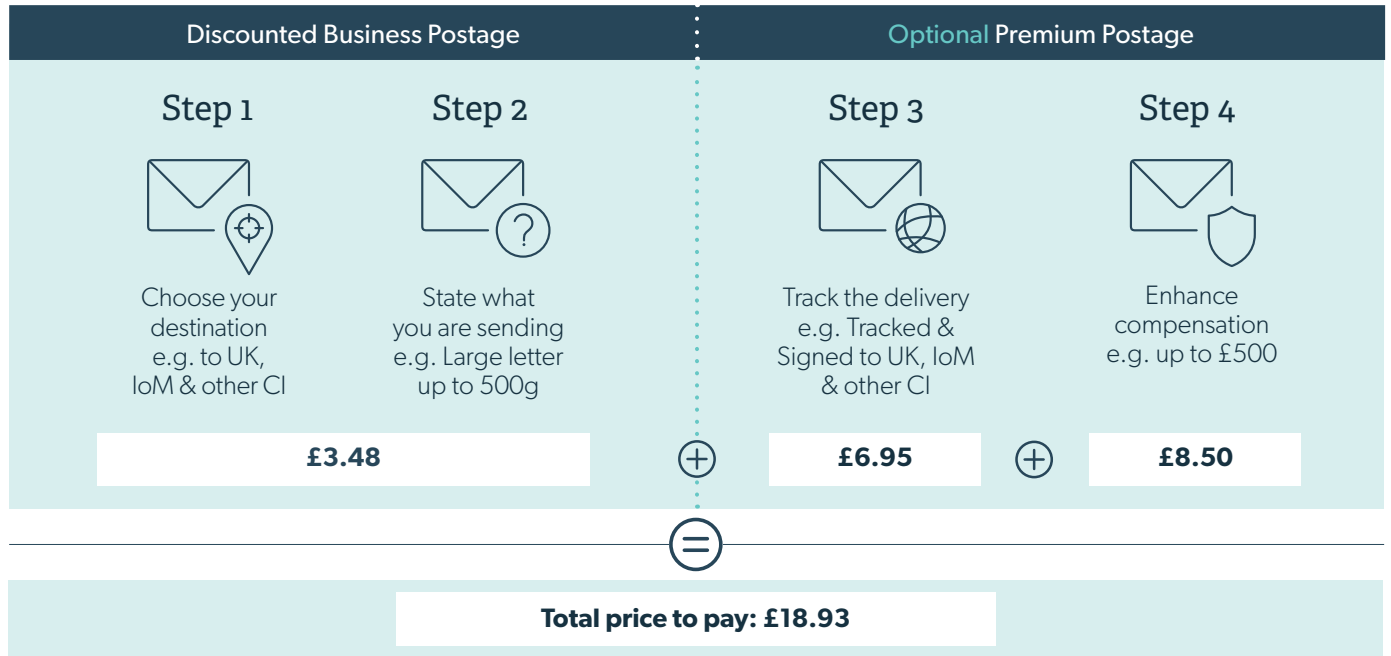

Unpaid and Underpaid postage

Prior to delivery, we need you or the receiver to pay any unpaid or underpaid amounts due plus a surcharge fee of £1.35 per item of mail.

Courier

Our Courier service uses the global secure and speedy network of our partner FedEx, the world's leading and largest express transportation company. Once an item enters this network, FedEx takes sole responsibility for its transport and delivery.



Customers should use our Courier service when:

- Sending important or high-value items and wanting to minimise the risk of loss or delay
- Sending time-critical items that need delivery within an assured time period to UK, Europe and Rest of the World destinations
- Requiring frequent, automatic progress updates on an item from sending to final destination

How is Courier different than our other postage services?

Feature	Signed for	Tracked & Signed	Courier
Destinations available	170	70	220
Signature on delivery	✓	✓	✓
Online progress tracking		✓	✓
Automatic progress updates			✓
Money back guarantee			✓
Multiple delivery attempts			✓
Free packaging supplied			✓
Priority customer support			✓
Delay cover			✓
Inclusive compensation cover	Up-to-£30	Up-to-£100	Up-to-£500

UK deliveries

Send documents to the UK, Isle of Man and other Channel Islands, for delivery* by either 09:00, 10:00 or 12:00 on the next working day.

Worldwide deliveries

Send documents and goods to Europe and Rest of the World destinations, for delivery within the expected following timescales:

Worldwide deliveries	
To UK	Next working day
To Europe	Two working days
To USA & Canada	Two working days
To Latin America & the Caribbean	Three working days
To Middle East & Asia	Three working days
To Africa & Oceania	Four working days

Please contact our Business Sales team on 616617 or email fedex@jerseypost.com to discuss your Courier requirements.

* Subject to terms and conditions which include correct address and accompanying documentation, and someone being present to receive the item – see our General Postage Terms & Conditions for full details at www.jerseypost.com.

Online Postage Portal

Benefit from a 2% postage discount online

Use our online postage portal to buy, create and print your postage and electronic pre-advice customs labels. If you have a business credit account with us, we can link it to the postage portal, so any charges will be billed to your account on a monthly basis.

How it works:

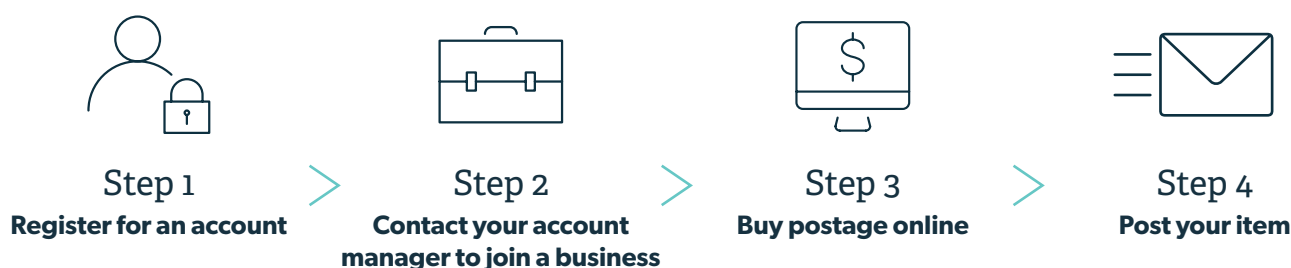

Using these services online will also provide you with relevant information and instruction regarding our range of business services. Whether you're sending items locally, to the UK, Europe or further afield, you can now print labels wherever you are at a time convenient to you.

Payments for our online postage services can be made using a debit/credit card. Alternatively, if you are an existing Jersey Post account customer you can have these services added to your monthly billing. For more information or to become an account customer, please contact business@jerseypost.com.

Register for this service for free by creating an online account at:
www.jerseypost.com/register

Business Accounts - Postage Account

Postage Account method requires pre-printed stationery or labels to be used for despatch and is ideally suited to those customers who want to present a consistent format with their postage.

Key Benefits:

- Ideal for business customers with moderate to high volume of letter mailings
- Offers support with import and export taxation to off-island destinations
- Invoices billed monthly, so easier to reconcile payments

Business Accounts - Outsourced Mailroom

Invoiced monthly, our mail processing services take away the additional work involved in organising your business' daily postage needs. With no additional paperwork to complete, just simply pass your mail onto our processing staff and we will take care of the rest.

Key Benefits:

- Ideal for business customers with moderate to high volume usage
- Ideal for business customers with no in-house mailroom or messenger for mail despatch.
- Consistency of service
- Invoiced monthly, meaning that postage costs can be managed.
- Avoid the additional costs that can be incurred through running your own franking meter.

Additional Outsourced Mailroom handling fees:

Element	Fee
Contracted customers and ad hoc (per item)	14p
Unsorted mail (per item)	14p
Ad hoc mailing handling fee	£30.00
All items needing hand franking (per item)	28p
Hand franked items handling fee	£30.00

Business Accounts - Franking Meter

Applying postage to items via a franking meter provides businesses with a quick and convenient method of postage for moderate to high volume of letter mailings.

Key Benefits:

- Convenient way of applying and paying for postage
- Postage costs are managed and controlled by the organisation

Franking Meter Suppliers

Franking meter machines can be rented or purchased from Office Solutions, who would be happy to talk to you in more detail about franking meter machines.

Prepaid Import VAT Accounting Scheme

The IVAS scheme was set up between HM Revenue & Customs, Jersey Customs & Immigration and Jersey Post to allow customers to prepay the VAT due on items being sent to the UK.

Customers on the scheme send their declarations and VAT payments to Jersey Post on a monthly basis and these are collated and then forwarded onto HM Revenue & Customs on their behalf.

For more information, please contact our Business Services Team.

Business Redirection and Retention of Mail

Business Redirection Service

Minimise the impact of an office relocation on your valued customers by using our redirection service. This will ensure uninterrupted mail deliveries during and after your relocation.

Business Redirection (per business name) prices:

Duration	Local	UK, IOM & other CI	EU and Rest of World
1 month	£57.00	£150.00	£217.00
3 months	£117.00	£323.00	£444.00
6 months	£203.00	£557.00	£764.00
12 months	£364.00	£979.00	£1,470.00

Retention of Mail Service

Maximum duration for our Retention of Mail services is two calendar months.

Retention of Mail prices:

Duration	Price
2 months	£35.00

These services are free of charge for PO Box and Premium Postcode customers.

Business Delivery Services

Our Business Delivery service allows you to customise how you'd like your mail delivered.

Business addressing options

Address Type	Set up fee	Annual fee
PO Box Number A short, memorable address which is ideal for any size of organisation.	£130.00	£140.00
Premium Postcode A unique, customisable postcode starting JE1 that reflects your organisation's name or brand.	£130.00	£140.00
Standard Address Your physical address associated with your business premises.	Free	Free

Receiving or collecting your mail

Service	Fee
Standard Postal Service Have your mail delivered to your premises on a standard delivery round, at various times before 5pm each weekday.	Free of charge
Business Collect Your mail is held for collection in person, from either Broad Street (9am-5pm) or Rue des Pres post offices (8.30am-5.30pm) each weekday. This service is not applicable to businesses that use a Standard Address.	Broad Street: £135.00 per year Rue des Pres: £135.00 per year
Weekday Timed Collection	£227.00 per month
Combined Delivery & Collection	£420 per month

Connected business names (PO Box/Premium Postcode customers)

Additional names	
1 to 4 names	Free of charge
Over 4 names	£8.00 per name per year

Local Same Day Courier

Same Day Courier

Need an urgent same day delivery on island? We can offer fast, reliable door-to-door collection and delivery for ad-hoc requests received before midday.

- Deliveries throughout the working day
- Island-wide delivery options
- Discounted rates for regular deliveries

Service	Price per collection
Ad-Hoc Collection Service - up to 20 items/11kg	£30.00
Letter mail - Same Day Courier (within St Helier)	£20.00
Letter mail - Same Day Courier (outside St Helier)	£25.00

Mail Scanning Services

Mail Scanning Services

Receive your mail electronically, the same day it arrives, with our mail scanning service.

We'll collate and intercept your mail on arrival at our Postal Headquarters and deliver directly to our scanning partner, where your mail will be securely opened, scanned and electronic OCR copies sent to you via SFTP transfer, all before 11am each day.

A nominated administrator at your business can then distribute the OCR copies via email to the relevant staff and departments internally.

The physical copies of the scanned mail will be securely bagged up and delivered to your business premises the next working day.

Service	
Scanning – Set-up	£130.00 one-off
Scanning – Per page	£0.12 per sheet
Early Sort	£127.00 per month
Labour Rate	£30.00 per hour

Responses Services

Responses Services (Business Reply and Freepost)

Our Business Response services can help to improve your customer response rates by ensuring they can get in touch with you for free.

Business Reply

Our Business Reply service enables you to pre-print reply cards or envelopes with your address and pre-paid postage, removing the need for customers to address and stamp envelopes themselves.

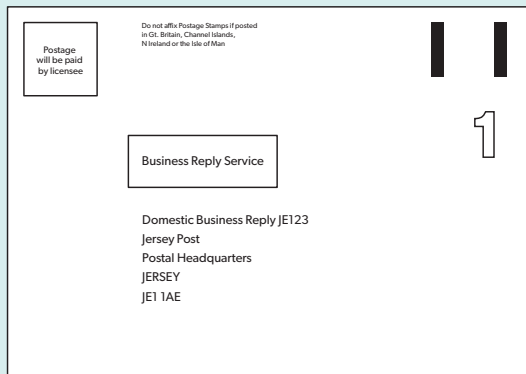

Freepost

Our Freepost Service offers even more flexibility, allocating you a simple Freepost number for customers to use when addressing a response to your business - perfect for customer engagement to promotional campaigns or regular customer mailings.

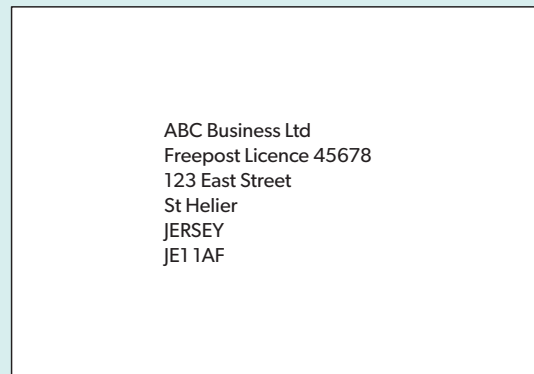

Response service license fees:

License fee	
Business Reply - Local, UK, Europe and RoW	£130.00
Freepost - Local, UK, Europe and RoW	£130.00
Unit/item charge + stamp rate	14p

Direct2home

Our Direct2home service is the Island's leading direct mail door drop service. You can choose an island-wide delivery if you're looking to maximise your coverage or by parish if you're looking for a more targeted approach.

Delivery points

Total Residential Delivery Points:

43,055

Total Business Delivery Points:

2,397

The below table provides an overview of the island's current delivery points by parish. Pricing is calculated per item, but is also dependent on weight and the number of delivery points you wish to reach.

1 St Ouen Home: 1,658 Business: 36	4 Trinity Home: 1,271 Business: 85	7 St Peter Home: 1,912 Business: 114	10 St Saviour Home: 5,747 Business: 184
2 St Mary Home: 777 Business: 41	5 St Martin Home: 1,819 Business: 47	8 St Lawrence Home: 2,280 Business: 58	11 Grouville Home: 2,230 Business: 37
3 St John Home: 1,332 Business: 51	6 St Brelade Home: 4,504 Business: 188	9 St Helier Home: 15,378 Business: 1,536	12 St Clement Home: 4,147 Business: 20

Rate card

Delivery Time (working days)	Weight Steps				Format	Distribution
	25g	50g	75g	100g		
5 (scheduled)	£0.13	£0.14	£0.15	£0.16	Any under 100g	All-Island or Parish

Find out more at jerseypost.com/direct2home

Van Advertising

Messages on the move!

Jersey Post van advertising provides businesses with marketing messages in vinyl wrap on the rear of one of Jersey Post Vans. Our fleet is out and about during peak times and throughout the day, so providing great island-wide coverage.

Service	
Van advertising	From £48.00 per month

Find out more at jerseypost.com/van-advertising

Fetch.je

Are you a local retailer that wants extra exposure and to sell your products online? Now that Fetch.je is part of the Jersey Post Group, we're offering local businesses the chance to feature on Jersey's favourite online marketplace to promote and sell products online.

How it works

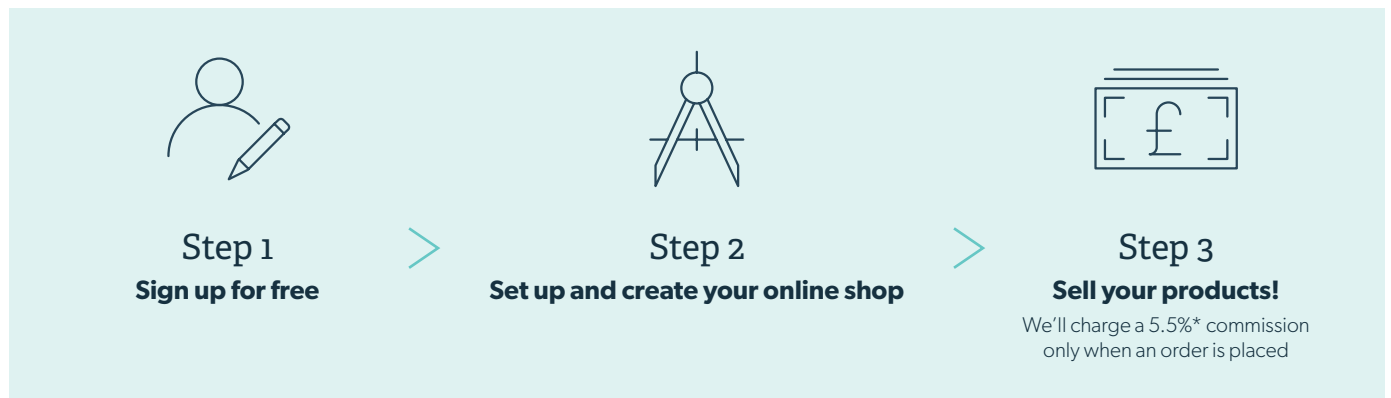

*Plus, the standard card administration fee.

Find out more at merchant.fetch.je/signup



Terms & Conditions

We provide all of our services according to a set of terms and conditions that define what customers should expect. Terms and conditions are important, and should be read carefully before applying for or using the product or service they relate to.

Please refer to our Business Terms & Conditions at www.jerseypost.com/terms

Prices correct at time of publishing. Please note these are subject to change.
Please refer to the website for the most current information.

t: 616617
e: business@jerseypost.com
www.jerseypost.com/pricing

**Jersey
Post** 